

The copying, distribution and utilization of this document as well as the communication of the contents to others without expressed authorization is prohibited according to §18 UWG German Law. Offenders will be held liable for the payment of damages according to §19 UWG German Law. All rights reserved, in particular the right to carry out patent, utility model or ornamental design registrations.

Weitergabe sowie Vervielfältigung dieses Dokuments, Verwertung und Mitteilung seines Inhalts gem §18 UWG verboten, soweit nicht ausdrücklich gestattet. Zuwiderhandlungen verpflichten zu Schadensersatz (§19 UWG). Alle Rechte vorbehalten, insbesondere das Recht, Patent-, Gebrauchsmuster- oder Geschmacksmusteranmeldungen durchzuführen. CONIVERS GmbH Heisenbergstrasse 1 D-71083 Herrenberg

Mechanical data (according to IEC 61076-2-101)	
Locking thread	M12 SPEEDCON
Material	
flange housing	GD-Zn, nickel-plated
sealing gasket	EPDM
nut	brass, nickel-plated
temperature range	-40 °C to +85 °C

further information:
- see installation recommendation SACC-M12-SCO NUT

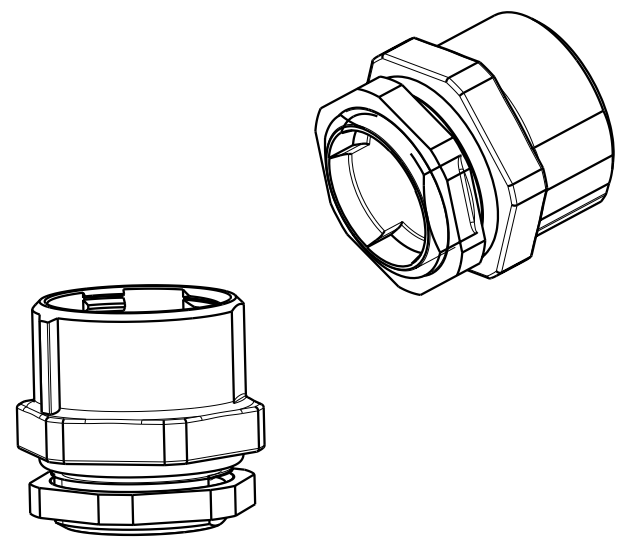
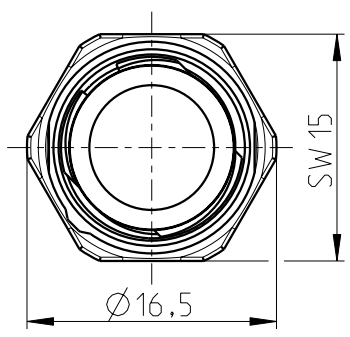
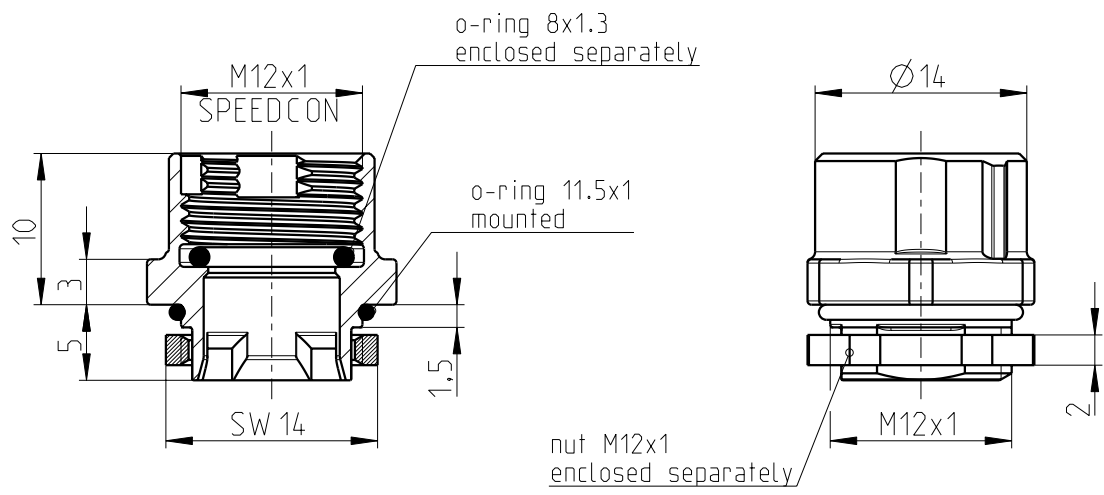

All specified data refers to the mounted M12 installation plugs ≥ IP54 and requires that the connector pair be correctly plugged and locked. Recommended tightening torque 0,4Nm. Influences from wires, cables or PCB mounting are also to be taken into consideration.

general tolerance acc. to DIN ISO 2768-c		technical changes reserved		Index 2 / 2012-11-26		scale: 2:1	
design	date	name		Series DSIV M12 SPEEDCON housing screw connection female SW 15 / screw connection / o-ring			
2012-04-12	Thumm						
chk.					page: 1 of: 1		
		drawing-no.:	BS-0000000M100		doc.-no.:	00655883	
		order-no.:	1552243				
		article designation:	SACC-M12-SCO NUT				